

ISOMETRIC

NOTE: KNOCKOUTS-STD,  
PENETRATIONS-OPTIONAL

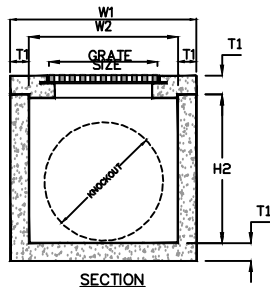

MARK		QTY		DESCRIPTION
1	1	1		GRATE OR COVER AS REQUESTED, SEE OPTIONS
2	1	1		CAST-IN STEEL FRAME
3	1	1		OPTIONAL TOP/EXTENSION 6" TO 18"
4	1	1		PRECAST CONCRETE BASIN SECTION
5	4			KNOCKOUTS (STD) AND PENETRATIONS (OPT) AS REQUIRED, SEE KO DIMENSION FOR MAXIMUM PIPE O.D.*
6	1			NAMEPLATE INDICATING: MFG: PARKUSA 888-611-PARK WWW.PARKUSA.COM MODEL: CB-01 DATE MANUFACTURED

ADDITIONAL OPTIONS

REMOVABLE DEBRIS SCREEN w/ (2) LIFT HANDLES,  
304 STAINLESS STEEL, 1/2" HOLES @ 3/4" o.c. (50%  
FREE OPEN AREA)

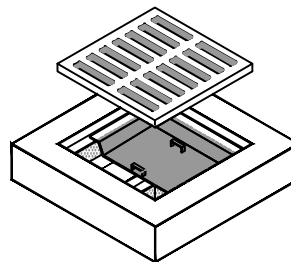

HIGH DENSITY POLYETHYLENE (HDPE) LINER w/  
ANCHORS

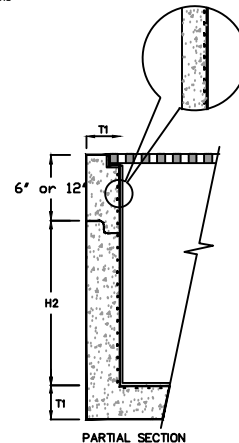

COVER OPTIONS

ACID RESISTANT FRP GRATING, w/ STAINLESS STEEL  
FRAME (PEDESTRIAN DUTY)

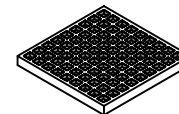

GRATING: GRATING  
SHALL BE  
ACID-RESISTANT  
FIBERGLASS GRATING w/  
STAINLESS STEEL ANGLE  
FRAME.

SKID-RESISTANT STEEL PEDESTRIAN DUTY STD.

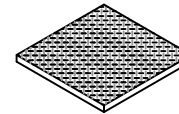

D.I. CASTINGS: MANHOLE  
FRAMES, COVERS OR  
GRATES ARE  
MANUFACTURED OF  
DUCTILE IRON  
CONFORMING TO ASTM  
A536, AASHTO M306, &  
AASHTO M102  
STANDARDS.

TRAFFIC DUTY CAST IRON GRATE

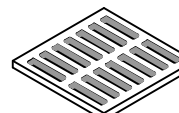

D.I. CASTINGS: MANHOLE  
FRAMES, COVERS OR  
GRATES ARE  
MANUFACTURED OF  
DUCTILE IRON  
CONFORMING TO ASTM  
A536, AASHTO M306, &  
AASHTO M102  
STANDARDS.

CAST IRON FRAME & GRATE V5600-SERIES

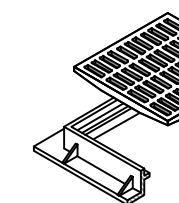

D.I. CASTINGS: MANHOLE FRAMES, COVERS OR GRATES ARE  
MANUFACTURED OF DUCTILE IRON CONFORMING TO ASTM A536,  
AASHTO M306, & AASHTO M102 STANDARDS.

© ParkUSA. ALL RIGHTS RESERVED.

MODEL	W1	W2	H1	H2	T1	T2	KO	GRATE SIZE	OPEN AREA	WEIGHT LBS
CB-12	15"	10"	21"	18"	3"	2 1/2"	10"	12"x12"x1"	90	180
CB-14	20"	12"	28"	24"	4"	4"	12"	14"x14"x1 1/2"	120	600
CB-18	24"	16"	34"	30"	4"	4"	15"	18"x18"x1 1/2"	168	1,000
CB-20	26"	18"	34"	30"	4"	4"	17"	20"x20"x1 1/2"	170	1,335
CB-24	32"	22"	41"	36"	5"	5"	22"	24"x24"x2"	268	2,245
CB-27	37"	25"	42"	36"	6"	6"	24"	27"x27"x2"	350	2,875
CB-30	42"	30"	42"	36"	6"	6"	30"	32"x32"x2"	490	3,675
CB-36	48"	36"	42"	36"	6"	6"	32"	38"x38"x2"	693	4,585
CB-48	60"	48"	54"	48"	6"	6"	48"	38"x38"x2"	693	7,250
*CB-60	72"	60"	66"	60"	6"	6"	60"	38"x38"x2"	693	10,500
*CB-72	84"	72"	78"	72"	6"	6"	72"	38"x38"x2"	693	15,350
*CB-84	96"	84"	78"	72"	6"	6"	72"	38"x38"x2"	693	19,500

\*KNOCKOUTS NOT AVAILABLE

SPECIFICATIONS

CONCRETE : CLASS I/II CONCRETE WITH OF DESIGN STRENGTH OF 4500 PSI AT 28 DAYS. UNIT IS OF MONOLITHIC CONSTRUCTION AT FLOOR AND FIRST STAGE OF WALL WITH SECTIONAL RISER TO REQUIRED DEPTH.

REINFORCEMENT: GRADE 60 REINFORCED. STEEL REBAR CONFORMING TO ASTM A615 ON REQUIRED CENTERS OR EQUAL.

C.I. CASTINGS: CAST IRON FRAMES AND GRATES ARE MANUFACTURED OF GREY CAST IRON CONFORMING TO ASTM A48-76 CLASS 30.

MARK: -  
LINE: -  
STA: -  
SHEET: -  
DATE: -

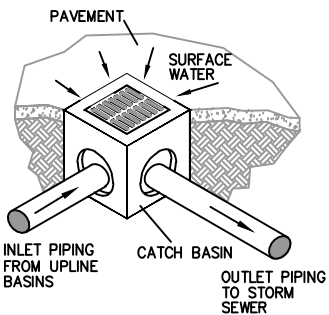

REV	DATE	BY	DESCRIPTION
A	.	.	.

PROJECT: .  
CUSTOMER: .  
ENGINEER: .  
ORDER #: . PROJ #: .  
DATE: . LOCATION: .



CATCH BASIN  
MODEL CB - 12" THRU 84"

PM	PC	DRN	ENG	DWG. NO.	REV.
.	.	.	.	CB-1	A

CREATED ON 4/19/2024 BY . . . . .  
LAST MODIFIED ON 4/19/2024 3:18 PM BY kw

PLOTTED ON 4/19/2024 3:18 PM BY Yu. Kats. C:\Users\Yu\Desktop\Files\replacement\_webarta\CB-1